

Joli

CERAMIC BASIN-TOP 600MM

Features

- Soft curve design
- 18 mm thick vitreous china
- Gloss white finish
- 3 mm tile lip
- 12 o'clock tap hole as standard (3 tap holes also available)
- Integrated overflow
- Chrome overflow ring included
- Requires 32 mm overflow waste (available separately)

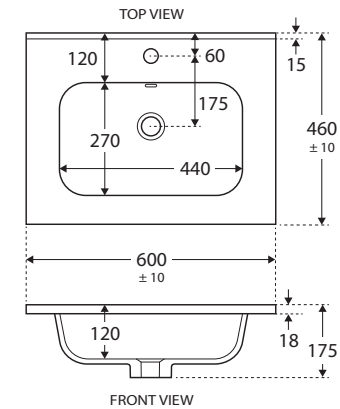

Available in



1 tap hole
JOL60



3 tap hole
JOL60-3

Cleaning & Care

- Wipe with a clean, soft cloth and mild soapy water or non-abrasive bathroom cleaner. Test in an inconspicuous area before cleaning the whole top.
- Avoid placing hot objects, such as hair straighteners, on any surface as these will cause discolouration and marking.
- Spills of hair dye, after-shave lotion, nail polish and remover, aerosol spray and other harsh chemicals should be removed immediately to prevent damage and discolouration. Clean immediately with mild soapy water using a clean, soft cloth.

While we aim to ensure specifications are correct at the time of publication, Fienza reserves the right to make modifications without prior notice. Physical colour may vary from image shown. All measurements are shown in millimetres. For ceramic products, please allow +/- 10 mm tolerance for manufacturing variance. Always use physical product measurements for mark-ups and roughing-in as the technical drawing may differ from actual product received.