

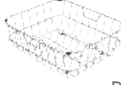

**Model Code: EN200L**

### Included Accessories

		
ICP12	6020	Seal Strip

### Optional Accessories

		
DR006	AQCB	ADT1

### Dimensions

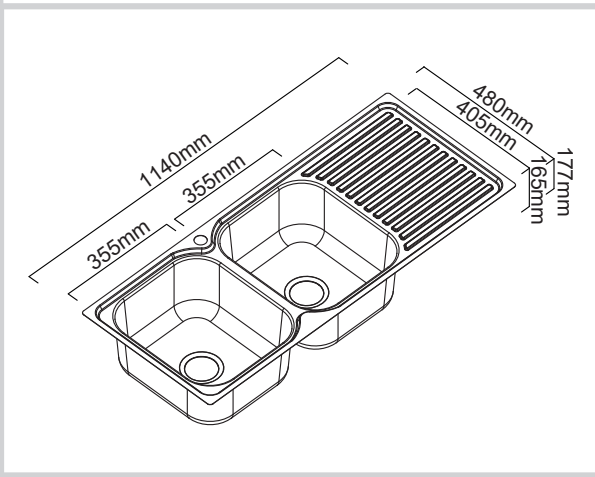

### Specifications

Description	Double bowls with one Drainer, Inset sink
Overall Sink Size	1140mm x 480mm x 177mm deep
Bowl Dimensions	355mm x 405mm x 165mm deep 355mm x 405mm x 165mm deep
Drainer Length	358mm
Technic	Pressed
Material	Stainless steel SUS304

### Installation

Fixings	Inset clips supplied
Template	Supplied
Min Cabinet Size	800mm
Waste Holes	2x 90mm round Compatible with waste disposal

### Plumbing

Waste Fittings	2 x (90mm x 2") basket waste included
Overflow	Available, conditions apply

### Packaging

Carton Type	EPS protection & individual sleeve
Gross Weight	4.3Kg
Carton Size	1188mm x 526mm x 205mm
Pack QTY	1

#### SURFACE FINISH

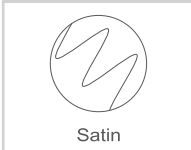

#### WASTE KIT

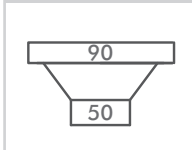

#### MATERIAL



#### INSTALLATION OPTIONS

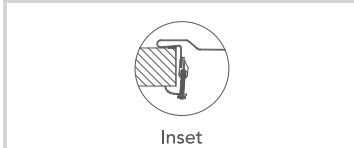

#### PROFILE

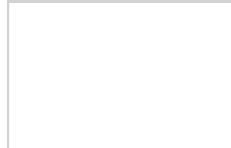

Abey are Australia's leaders in sinkware, designing and manufacturing to the world's highest quality specifications as well as sourcing and bringing you Europe's very best, leading edge designs – practical, affordable, inspirational, stylish, timeless or cutting edge. When you buy an Abey stainless steel sink you receive the highest quality and 25 year warranty. Abey and the manufacturer are continually seeking ways to improve the design specifications, aesthetic and production techniques of the products. As a result, alterations to the specifications and dimensions of the products and designs occur continually.