





Model Code: LT100

Included Accessories

		
ICM8	UMC8	6020/OFLOW4

Optional Accessories

Dimensions

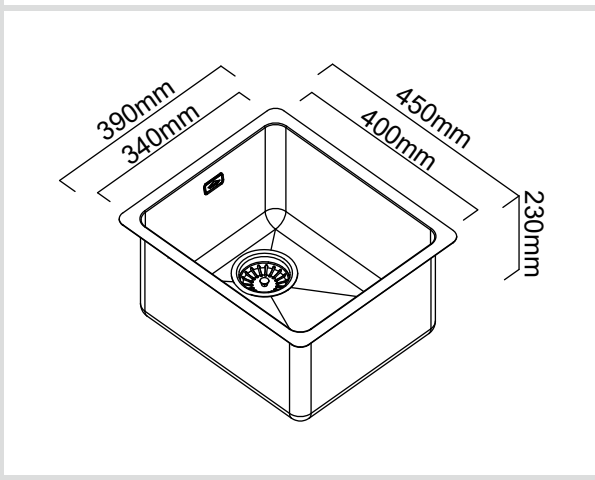

Specifications

Description	Single bowl, Inset/Undermount Sink
Overall Sink Size	390mm x 450mm x 230mm deep
Bowl Dimensions	340mm x 400mm x 230mm deep
Drainer Length	N/A
Technic	Fabrication
Material	Stainless steel SUS304

Installation

Fixings	Inset & Undermount clips supplied
Template	N/A
Min Cabinet Size	450mm
Waste Holes	1 x 90mm round Compatible with waste disposal
Sealing Strip	N/A

Plumbing

Waste Fittings	1 x (90mm x 2") basket waste included
Overflow	Rectangular Overflow

Packaging

Carton Type	Eco packaging & Individual carton
Gross Weight	6.2Kg
Carton Size	455mm x 330mm x 540mm
Pack QTY	1

SURFACE FINISH



WASTE KIT

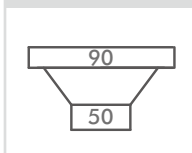

MATERIAL

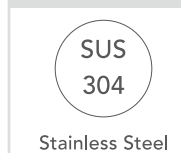

INSTALLATION OPTIONS

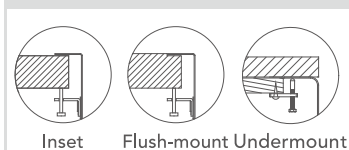

PROFILE

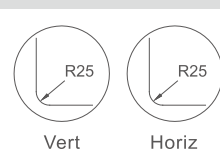

Abey are Australia's leaders in sinkware, designing and manufacturing to the world's highest quality specifications as well as sourcing and bringing you Europe's very best, leading edge designs – practical, affordable, inspirational, stylish, timeless or cutting edge. When you buy an Abey stainless steel sink you receive the highest quality and a 25 year warranty. Abey and the manufacturer are continually seeking ways to improve the design specifications, aesthetic and production techniques of the products. As a result, alterations to the specifications and dimensions of the products and designs occur continually.