

SINGLE HEATED + NON-HEATED







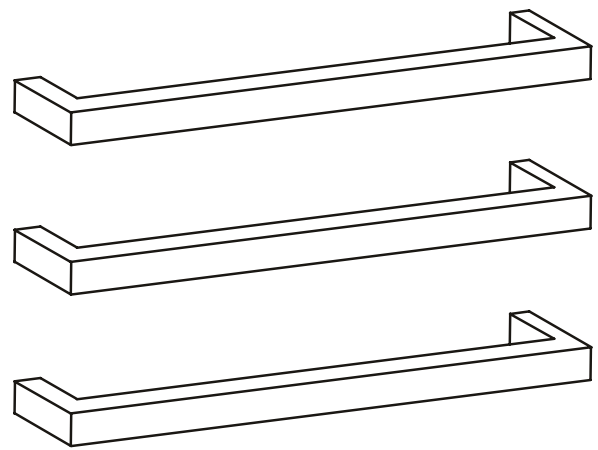

SBSTR – 500 / 650 / 800

MIRROR POLISHED AND SATIN BRUSHED
 MANUFACTURED FROM 304 GRADE
 STAINLESS STEEL
 COLOURED FINISHES MANUFACTURED
 FROM 201 GRADE STAINLESS STEEL
 IP55 RATED
 10 YEAR WARRANTY FOR CONSTRUCTION /
 HEATING ELEMENT
 COATING ON COLOURED RAILS ARE
 COVERED BY A 2 YEAR WARRANTY

If **heating** the single towel rails you
 will need to purchase the items below:

CODE	SPECIFICATIONS
TTR300	70/105 watt transformer for up to 4 rails (not required if installing as non-heated)
SB-FIX	Single bar fixing rail (not required if installing as non-heated) for up to 4 rails



FEATURES	CODE	WATT	SIZE (MM)	FINISH	
• Single square bar / 12V	SBSTR-500	12W	80x500	Polished	
• Can be used as heated and non-heated	SBSTR-650	12W	80x650	Polished	
• Available in various widths: 500, 650, 800	SBSTR-800	15W	80x800	Polished	
• Distance from the wall: 80 mm	BRU-SBSTR-500	12W	80x500	Satin Brushed	
• Width between fixing holes: (500) = 480mm	BRU-SBSTR-650	12W	80x650	Satin Brushed	
(650) = 630mm	BRU-SBSTR-800	15W	80x800	Satin Brushed	
(800) = 780mm	BSBSTR-500	15W	80x500	Matt Black	
	BSBSTR-650	20W	80x650	Matt Black	
	BSBSTR-800	22W	80x800	Matt Black	