

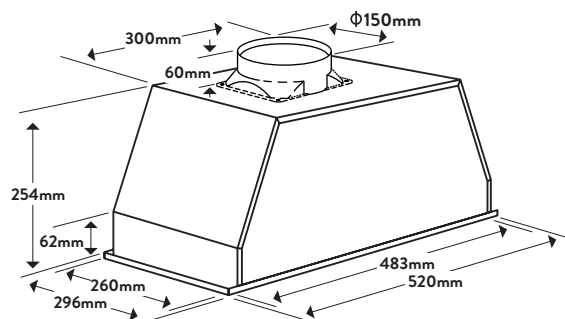

## Dimensions/Weight

Overall dimensions (mm): 254(h) x 520(w) x 296(d)  
 Duct diameter(mm): 150  
 Weight: 8.5kg



## Technical details

### Style

Rangehood Type: Undermount  
 Category Size: 52cm

### Functionality

Extraction Type: Ducted  
 Extraction Rate: 683m<sup>3</sup>/hr Net  
 1000m<sup>3</sup>/hr Gross  
 Number of Motors: 1  
 Watts of Motor: 265w  
 Speeds: 3  
 Filtration: 1 x Aluminium Mesh  
 Lights: 2 x 3w LED  
 dBA Rating: 54-68

### Installation

Maximum Current: 10amps  
 Connection: 240v, 50Hz  
 Installation Type: Built Into Overhead Cabinetry

Warranty: 24 Months Parts & Labour

## Aesthetics

Finish: Matte Black Fascia & Filter  
 Controls: Slide Switch  
 Control Location: Concealed Front Centre

## Key Features



### LED Light

LED lights use a small amount of energy, generate little heat and last a long time. Not only are they cost effective, they will ensure your cooktop is well lit.



### Washable Filter

The removable, washable filter is easy to maintain and keep clean ensuring your rangehood always performs well.



### Matte Black Finish

Black is on trend making this rangehood a great addition to your new or updated kitchen.

## Customer Care

T: 1300 739 033 (AU)

09 415 6000 (NZ)

E: [customercare@omegaappliances.com.au](mailto:customercare@omegaappliances.com.au)

[customercare@monacocorp.co.nz](mailto:customercare@monacocorp.co.nz)

Updated 30/01/2020 - V1

NB: Drawings are not to scale - they are to assist only.

WARNING: technical specifications and product sizes can be varied by the manufacturer without notice. Cutouts for appliances should only be by physical product measurements. The above information is indicative only.