

Puretec Sparq-S5

Filtered Sparkling, Chilled and Ambient Water

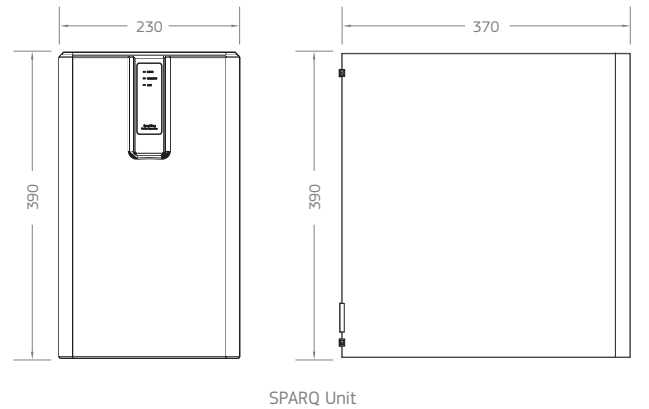

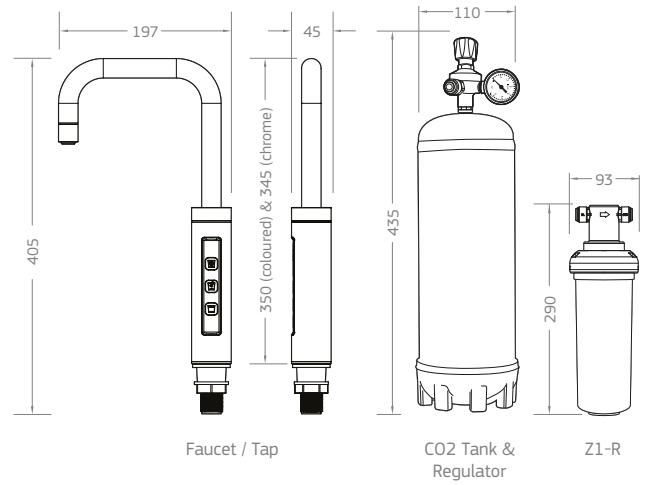



Parts Included



SPARQ Unit



Faucet / Tap

-  Gunmetal
-  Matte Black
-  Brushed Nickel
-  Chrome
-  Brushed Gold



SmartTee™



Multivalve



Z1-R



CO₂ Bottle and Regulator



User guide

Specifications

Ordering Code	Pressure kPa	Chilled Temp °C	Power Requirement	Warranty (year)	Tap Colour
SPARQ-S5-BG	138-500	2- 10	220-240 V / 50 Hz	2	Brushed Gold
SPARQ-S5-BK	138-500	2- 10	220-240 V / 50 Hz	2	Matte Black
SPARQ-S5-BN	138-500	2- 10	220-240 V / 50 Hz	2	Brushed Nickel
SPARQ-S5-CH	138-500	2- 10	220-240 V / 50 Hz	2	Chrome
SPARQ-S5-GM	138-500	2- 10	220-240 V / 50 Hz	2	Gunmetal

Notes:

Chilled Flow: 100 glasses per hour, 1/2" BSP (1/4" tube) connections, 100% stainless steel

Replacement Filter Cartridge	Temp °C	Pressure kPa	Filter Capacity	Micron Rating	Connection	Cartridge Size	Warranty (year)
Z1-R	0 - 38	200 - 520	30,000 L	0.1	1/2" BSP (1/4" tube)	10"	2

Warranty:

Use only genuine Puretec replacement cartridge. 2 year warranty is 1 year parts and labour plus 1 year parts only. Excludes consumables.



WaterMark
WMTS 105-2016
Certificate No. 23291
Pro-Switch Pty Ltd