







Model Code: EUA180L

## Included Accessories

		
ICP	6020	Seal Strip

## Optional Accessories

		
AQCB	DR006	

## Dimensions

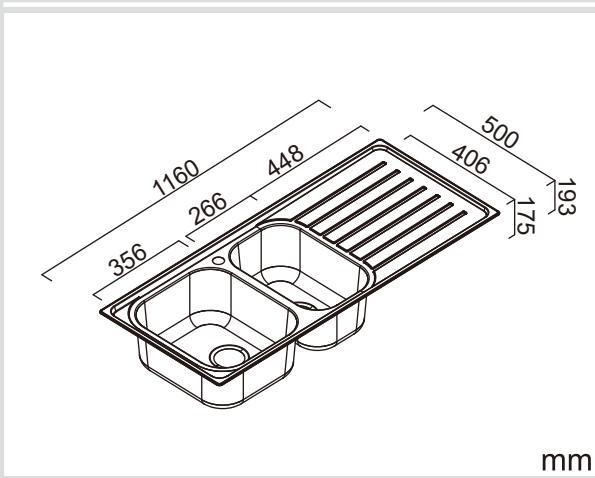

## Specifications

Description	Double bowl with one Drainer, Inset sink
Overall Sink Size	1160mm x 500mm x 193mm deep
Bowl Dimensions	356mm x 406mm x 175mm deep 266mm x 406mm x 175mm deep
Drainer Length	448mm
Technic	Pressed
Material	Stainless steel SUS304

## Installation

Fixings	Inset clips supplied
Template	Supplied
Min Cabinet Size	721mm
Waste Holes	2 x 90mm round Compatible with waste disposal

## Plumbing

Waste Fittings	2 x (90mm x 2") basket waste included
Overflow	Available, conditions apply

## Packaging

Carton Type	EPS protection & individual sleeve
Gross Weight	7Kg
Sleeve Size	1200mm x 540mm x 210mm
Pack QTY	1

<b>SURFACE FINISH</b>  Satin	<b>WASTE KIT</b>  90 50	<b>MATERIAL</b>  SUS 304 Stainless Steel
---	---	---



<b>INSTALLATION OPTIONS</b>  Inset	<b>PROFILE</b>
---	----------------

Abey are Australia's leaders in sinkware, designing and manufacturing to the world's highest quality specifications as well as sourcing and bringing you Europe's very best, leading edge designs – practical, affordable, inspirational, stylish, timeless or cutting edge. When you buy an Abey stainless steel sink you receive the highest quality and 25 year warranty. Abey and the manufacturer are continually seeking ways to improve the design specifications, aesthetic and production techniques of the products. As a result, alterations to the specifications and dimensions of the products and designs occur continually.





Model Code: EUA180R

## Included Accessories

		
ICP	6020	Seal Strip

## Optional Accessories

		
AQCB	DR006	

## Dimensions

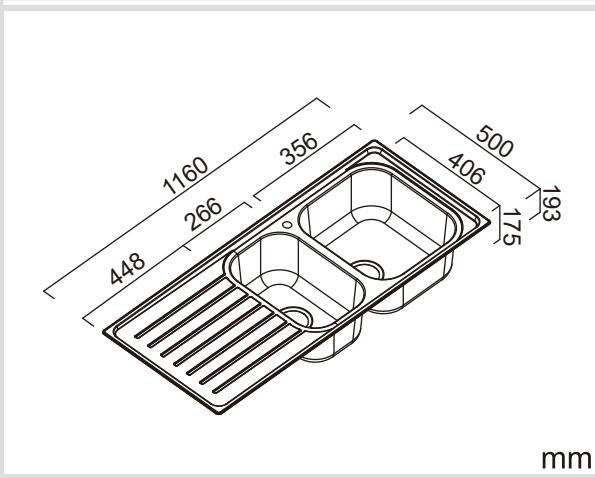

## Specifications

Description	Double bowl with one Drainer, Inset sink
Overall Sink Size	1160mm x 500mm x 193mm deep
Bowl Dimensions	266mm x 406mm x 175mm deep 356mm x 406mm x 175mm deep
Drainer Length	448mm
Technic	Pressed
Material	Stainless steel SUS304

## Installation

Fixings	Inset clips supplied
Template	Supplied
Min Cabinet Size	721mm
Waste Holes	2 x 90mm round Compatible with waste disposal

## Plumbing

Waste Fittings	2 x (90mm x 2") basket waste included
Overflow	Available, conditions apply

## Packaging

Carton Type	EPS protection & individual sleeve
Gross Weight	7Kg
Sleeve Size	1200mm x 540mm x 210mm
Pack QTY	1

### SURFACE FINISH



### WASTE KIT

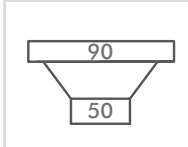

### MATERIAL



### INSTALLATION OPTIONS

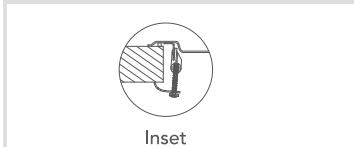

### PROFILE

