

Product information sheet SUBLINE 400-U

Item no. 526858

Benefits



- Undermount bowl for discerning demands on design
- Timelessly elegant, contoured bowl design
- Entire system for a wide variety of plans featuring large and small bowls
- High-quality features with covered C-overflow and InFino drain system – elegantly integrated and easy-care
- Optional versatile accessories are available

Colours



Available colours:

- black
- anthracite
- rock grey
- white

SILGRANIT anthracite

Planning information

- Cut-out radius: 10 mm

Scope of supply

- waste kit
- 3 ½" InFino basket strainer
- fixing kit

Details

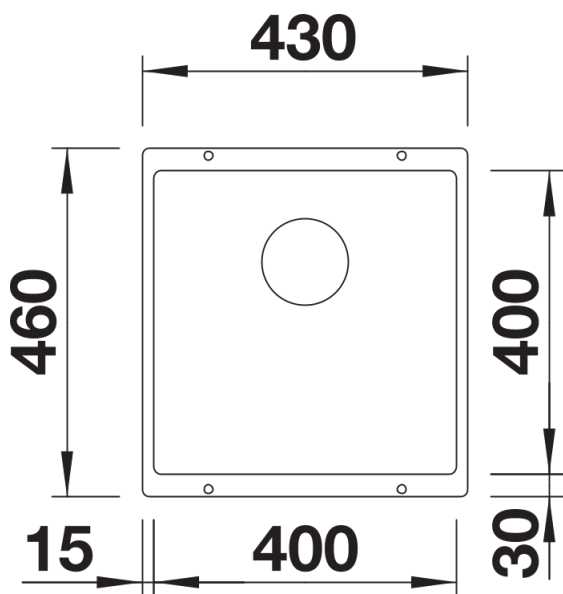

Top view

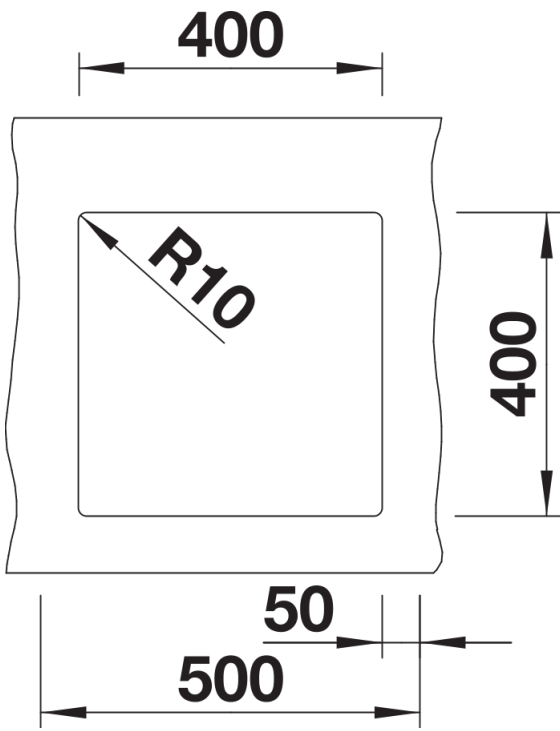

Cut-out

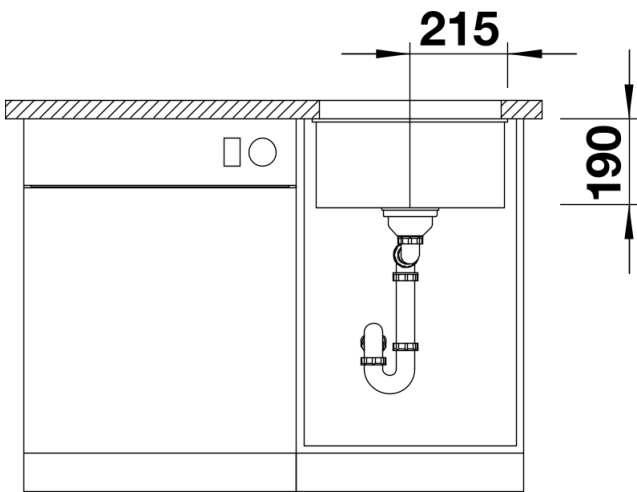

Front view

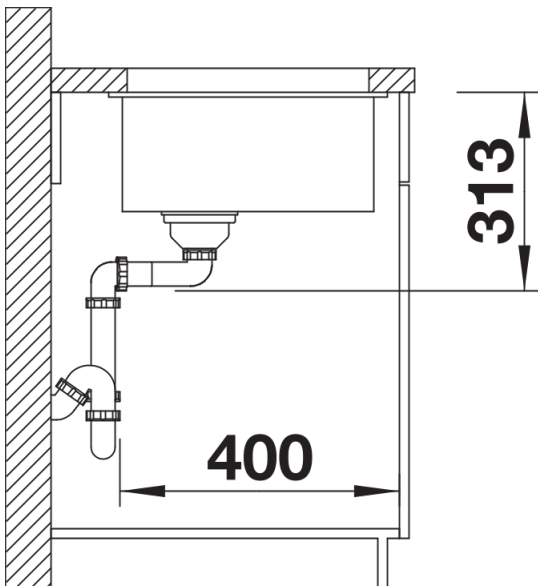

Side view