

Round Metal Project Rail Shower

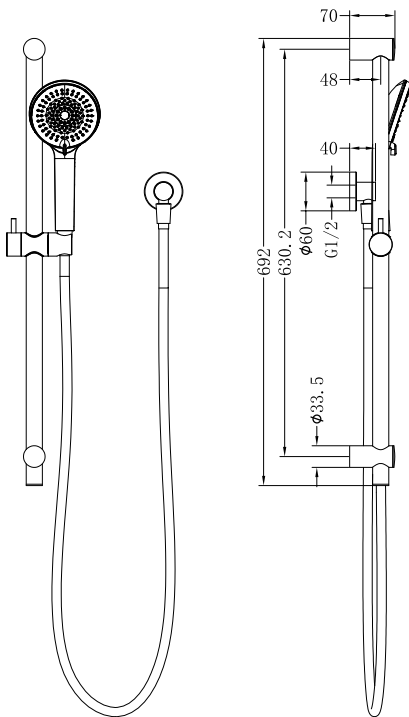





Dimensions are nominal measurements only.

SPECIFICATION

WELS RATING	3 STAR 9L/MIN
WATERMARK LICENSE	WM-060093
TEMPERATURE RATING	MIN 1°C-MAX 75°C
PRESSURE RATING	MIN 150KPa-MAX 500KPa

AVAILABLE FINISH

	CHROME NR318CH		MATTE BLACK NR318MB
	BRUSHED NICKEL NR318BN		GUN METAL NR318GM
	BRUSHED GOLD NR318BG		

MAINTENANCE AND CARE

All surfaces should be cleaned with mild liquid detergent or soap and water. Do not use cream cleaners or citrus based cleaning products, as they are abrasive. Use of unsuitable cleaning agents may damage the surface. Any damage caused in this way will not be covered by warranty.

PACKING INCLUDES

- 1x handle shower (built-in check valve)
- 1x shower hose
- 1x elbow
- 1x shower rail



Versions: V1

use Teflon tape



1. Put Teflon tape on outlet thread.

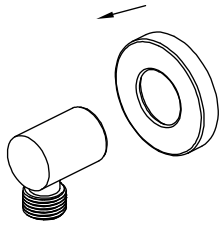

2. Pull dressing ring on the elbow body.

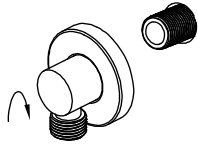

3. Screw elbow body on to outlet.

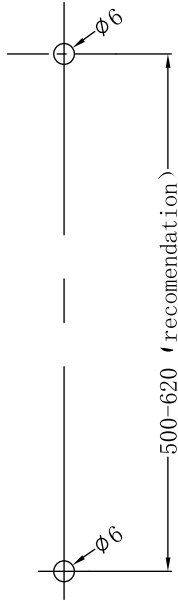

4. Drill two $\phi 6$ mm holes according to above picture.



5. Mount bottom bracket on the $\phi 6$ hole by expansion plug and tapping screw.

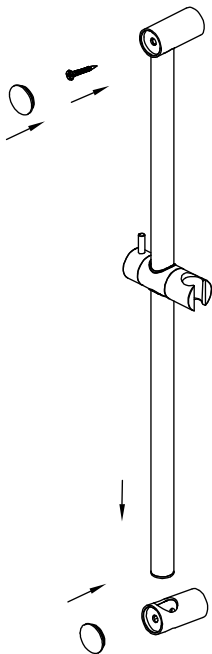

6. Plug shower rail in bottom bracket. Mount top bracket on the top hole by expansion plug and tapping screw. Push plates onto two brackets.

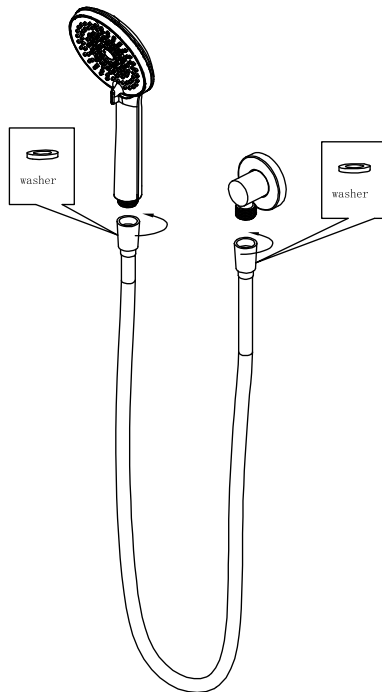

7. Connect hand shower with outlet by shower hose

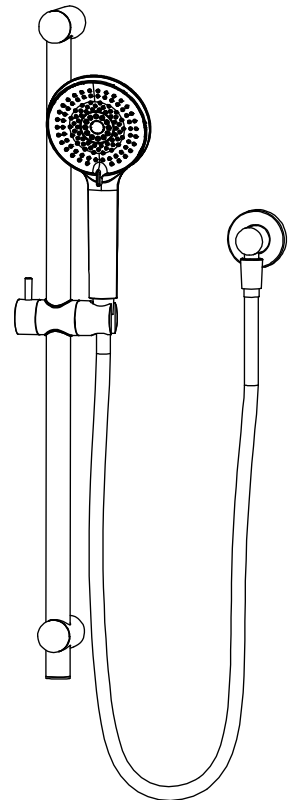

8. Test for leaks.